



More Precision

Confocal chromatic displacement sensors



optoNCDT 2401 Confocal displacement measurement system

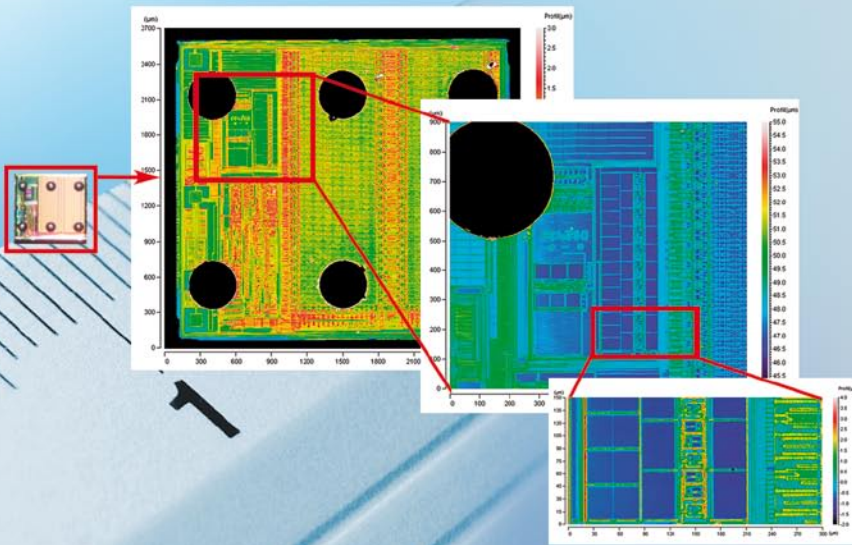

- Non-contact measurement principle
- Constant extreme small measuring spot
- Measures any reflecting target (direct and diffuse reflection)
- Submicrometer accuracy
- Direct reflection with no shadowing
- Speed up to 30kHz
- Measure multi-layer objects

The confocal measurement principle

Polychromatic white light is focused onto the target surface by a multilens optical system. The lenses are arranged so that the white light is dispersed into a monochromatic light by controlled chromatic aberration. A specific distance to the target is assigned to each wavelength by a factory calibration. Only the wavelength which is exactly focussed on the target is used for the measurement. This light reflected from the target surface is passed through a confocal aperture onto a spectrometer which detects and processes the spectral changes.

System set-up

The confocal chromatic measurement system, optoNCDT 2401, consists of a controller and a sensor. A fiber optical cable, up to 50m in length, connects the two components. This system has no moving components and is therefore wear free. It can also be used in ATEX / EX environments.

The system consists of a LED based controller a fiber optical cable and one of the sensor heads of the series 2400/2401/2403 or the world first miniature sensors series 2402.

A free demo software tool is included and offers fast access to system installation and data acquisition.

Performance and special features

This unique measuring principle enables displacements and distances to be measured with high precision and extreme spatial resolution. Both diffuse and specular surfaces can be measured. With transparent materials a one-sided thickness measurement can be accomplished along with the distance measurement.

Since the emitter and receiver are arranged in one axis, shadowing is avoided. In contrast to conventional triangulation sensors the optoNCDT 2401 system is able to measure in narrow apertures, small gaps and cavities. Furthermore, to analyse multi-layer objects, a multipeak software is available.

Measuring principle

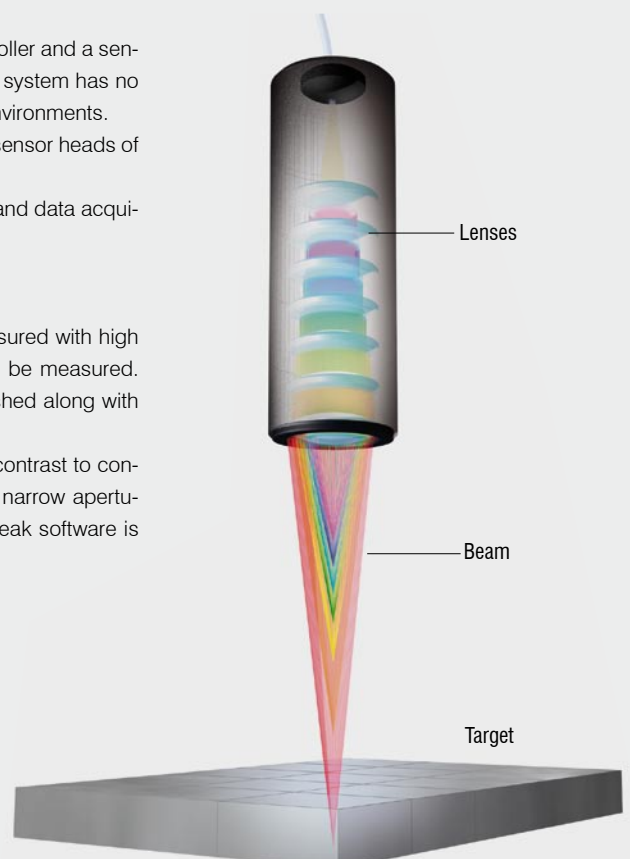

page 6-7

optoNCDT 2400/2401 Confocal displacement sensors

Compact sensors with large stand off distance possible
 One-sided thickness measurement of transparent materials and multi-layers
 Extreme high spatial resolution for microscopic surface profiling
 ATEX / EX approved for hazardous areas

LARGE STAND OFF DISTANCE

page 8-9

optoNCDT 2402 Confocal miniature sensors

Miniature sensors \varnothing 4mm
 One-sided thickness measurement of transparent materials and multi-layers
 Measure inside bores and cavities from \varnothing 4.5mm
 Robust housing (steel)
 Axial or radial (90°) measuring direction
 ATEX / EX approved for hazardous areas

MINIATURE SENSORS \varnothing 4mm

page 10-11

optoNCDT 2403 Confocal hybrid sensors

Hybrid sensors \varnothing 8mm
 One-sided thickness measurement of transparent materials and multi-layers
 Gradient index lens with relay optics
 Increased stand off
 Robust steel case
 ATEX / EX approved for hazardous areas

ENLARGED STAND OFF DISTANCE

Thickness measurement of transparent materials

The unique measurement principle enables a one-sided thickness measurement on transparent materials such as glass and plastic. Just one sensor measures the thickness with micrometer accuracy.

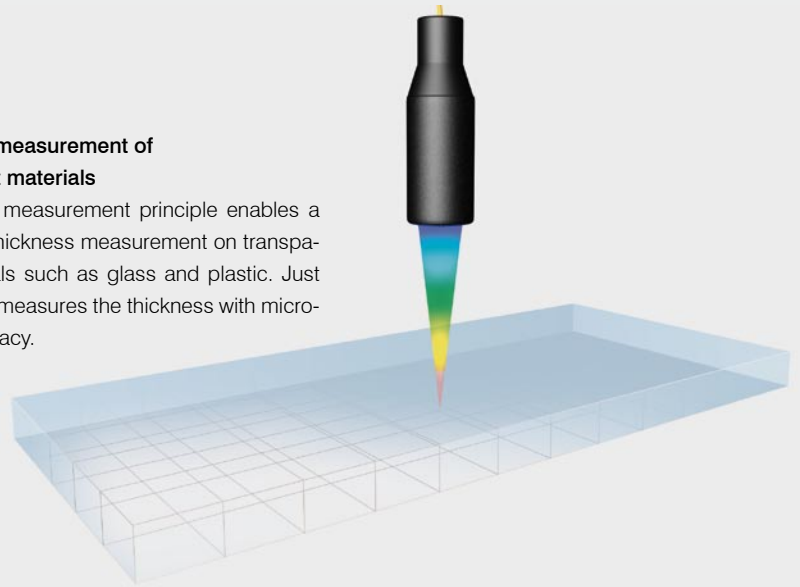

Gap measurement of laminated glass

Confocal sensors are used to measure the gap between the different layers of laminated glass.

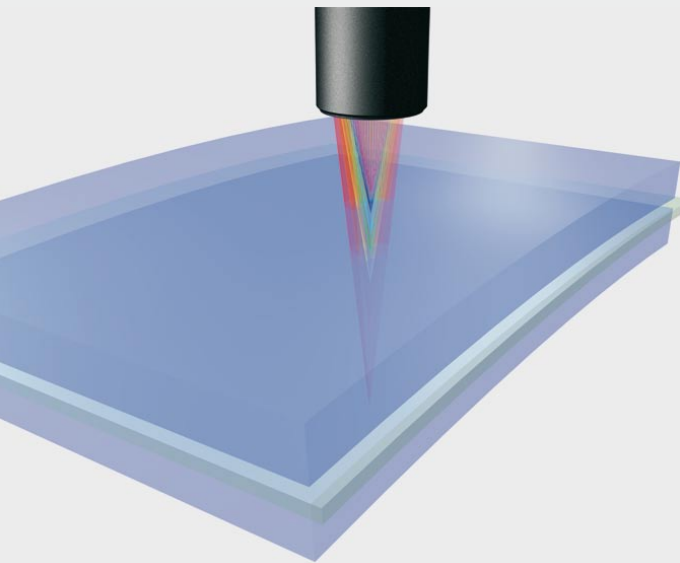

Liquid level control

Miniaturised confocal sensors check fill level in medical trays and microtiter plates, even if the surface is curved.

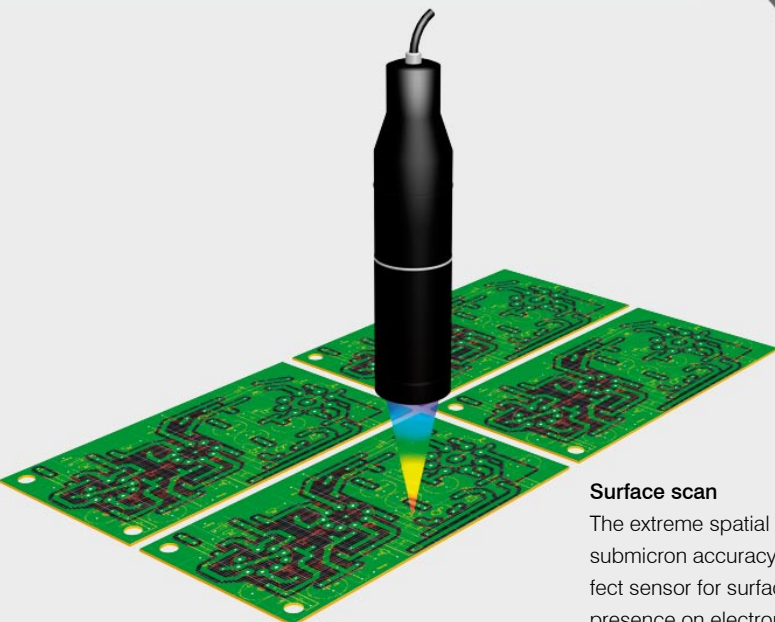
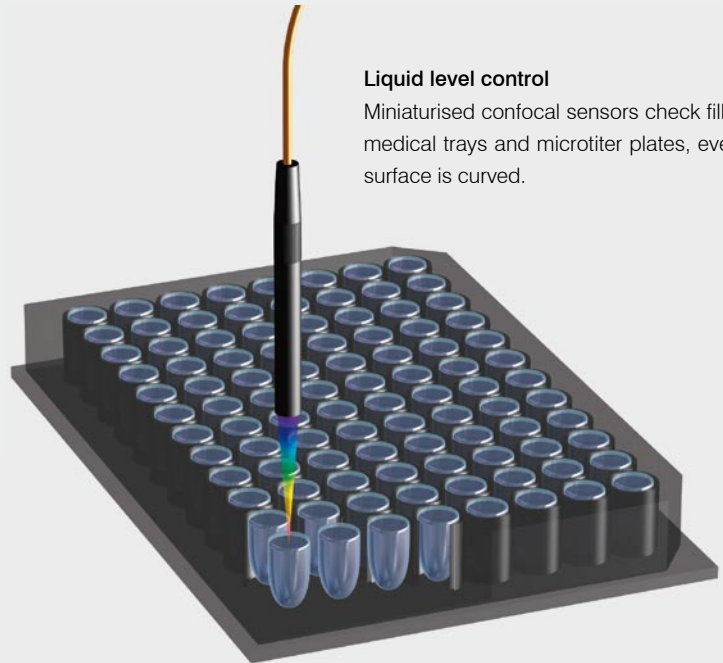

Surface scan

The extreme spatial resolution in x-axis and the submicron accuracy in the z-axis make it a perfect sensor for surface scans e. g. checking for presence on electronic boards.

Inspection of bores

Special miniature sensors with a diameter of 4mm measure in confined installation spaces, e.g. in drilled holes and recesses. Furthermore, the 90° version of these sensors enables measurement the very small inner diameters.

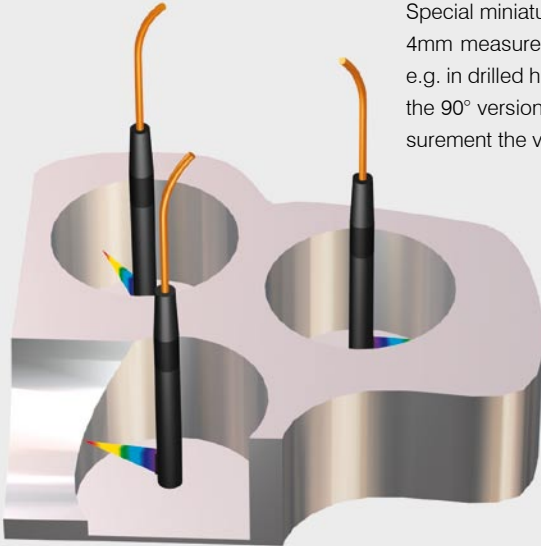

Cavity inspection

The 90°-version of the miniaturised sensors detects grooves or inner wall features of small gaps and cavities.

Thickness measurement in confined space

Two synchronised sensors acquire the base thickness inside sleeves.

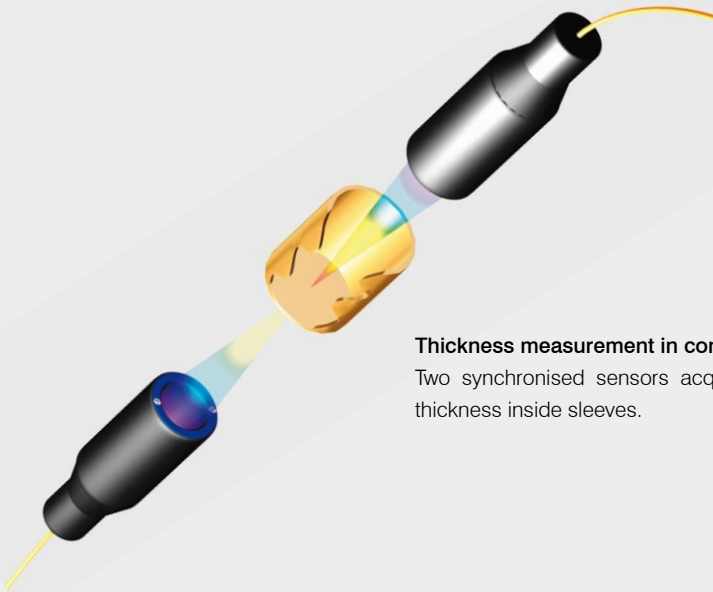

Wall thickness of transparent tubes

Due to one-sided thickness measurement, a single sensor is able to measure the thickness of glass, plastic tubes or any transparent coatings.

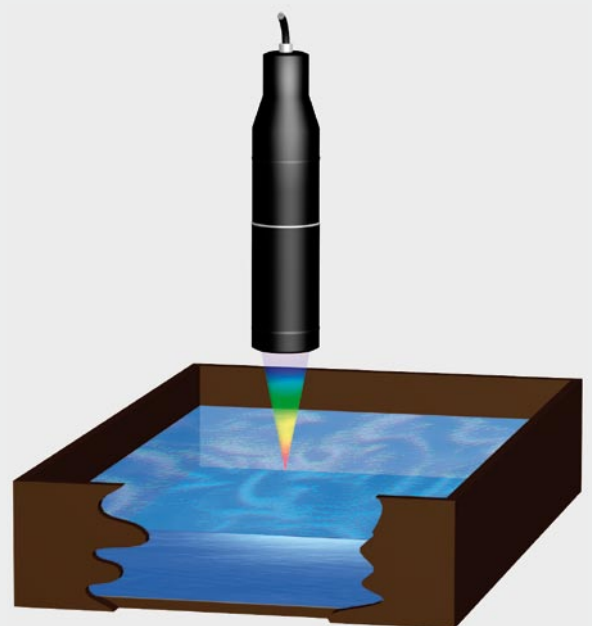
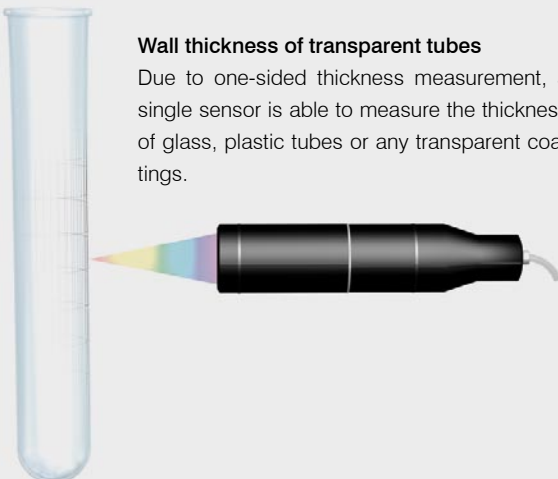

Liquid level

The confocal principle enables measurements on liquids and shiny targets.

optoNCDT 2400/2401 Confocal displacement sensors



- Compact sensors with large stand off distance possible
- One-sided thickness measurement of transparent materials and multi-layers
- Extreme high spatial resolution for microscopic surface profiling
- ATEX / EX approved for hazardous areas

The confocal sensors of the series 2400 and 2401 are applicable for distance and one-sided thickness measurement. The large tilt angle and the relative long stand off distance allow the use in many application fields. Measuring distance on shiny and transparent objects, one-sided thickness measurement; this sensor is ideal for precision measurement against any diffuse and specular materials e.g. film, liquid, glass, metal, polymer and many more.

IFS 2401-0.12

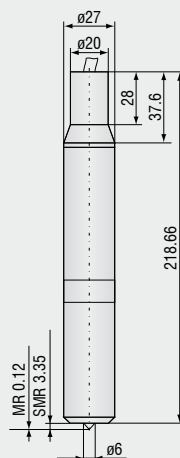

IFS 2401-0.4

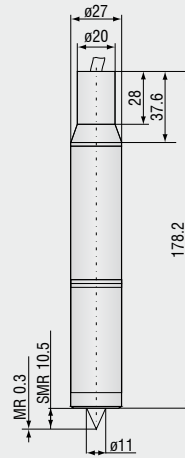

IFS 2401-1

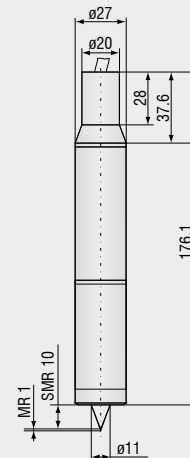

IFS 2401-3

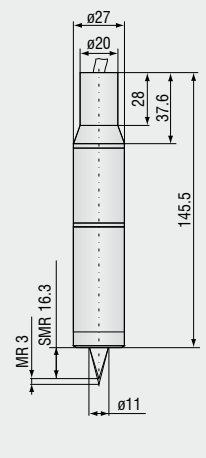

IFS 2401-10

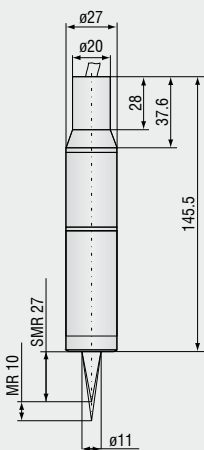

IFS 2400-10

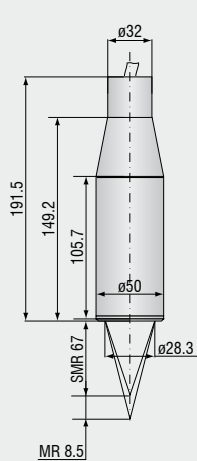

IFS 2400-20(01)

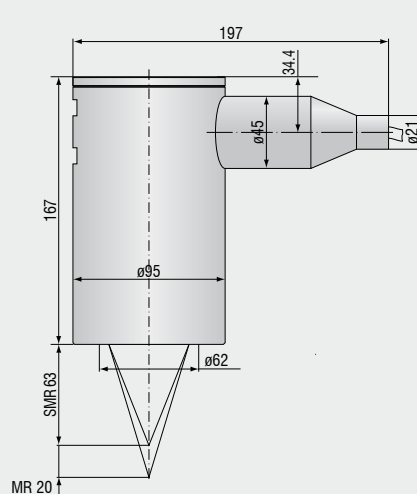

IFS 2400-24

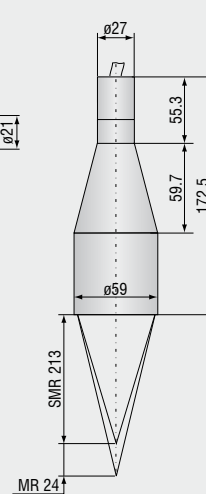

IFS 2401-25

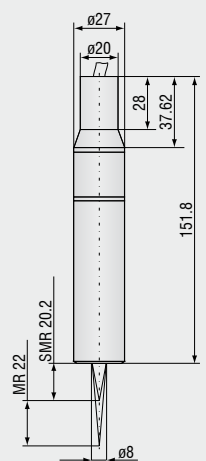

Tolerance: Total diameter +0.2 / -0.1 mm ; Single components ±0.1 mm

MR = Measuring Range SMR = Start of Measuring Range Dimensions in mm.

Controller		IFC2401								
		IFS 2401-0.12	IFS 2401-0.4	IFS 2401-1	IFS 2401-3	IFS 2401-10	IFS 2400-10	IFS 2400-20(01)	IFS 2400-24	IFS 2401-25
Measuring range		120µm	300µm	1mm	3mm	10mm	8.5mm	20mm	24mm	22mm
Start of measuring range	approx.	3.4mm	10.5mm	10mm	16.3mm	27mm	67mm	63mm	213mm	20.2mm
Spot diameter		7µm	10µm	10µm	25µm	50µm	50µm	100µm	100µm	100µm
Linearity		0.12µm	0.3µm	0.5µm	1.5µm	5µm	5µm	2.8µm	12µm	11µm
		≤ ±0.1% FSO		≤ ±0.05% FSO						
Resolution		~0.005µm	0.012µm	0.04µm	0.12µm	0.4µm	0.4µm	0.7µm	~1µm	~0.9µm
		0.004% FSO								
Weight	sensor	0.20kg	0.22kg	0.22kg	0.16kg	0.19kg	0.68kg	3.0kg	0.52kg	0.19kg
	sensor+MA 2400	0.38kg	0.40kg	0.40kg	0.34kg	0.37kg	0.90kg	-	0.76kg	0.37kg
Max. tilt (direct reflexion)		±43°	±28°	±27°	±22°	±14°	±14°	±20°	±5°	±8.5°
Measuring rate		adjustable 100Hz ... 2000Hz (optional 30kHz: series 2431 with external light source)								
Ambient light		30.000 lx								
Light source		LED								
Protection class (sensor/controller)		IP 40								
Temperature stability (sensor)		0.01% FSO / °C								
Operation temperature		+10°C ... +50°C								
Storage temperature		-30°C ... +70°C								
Output		2x 0 - 10V (15 Bit) / RS 232 / RS 422 / USB 2.0								
Supply		24VDC								
Sensor cable (fiber optic cable)		length: standard 3m; option up to 50m bending radius: static 30mm; dynamic 40mm								
Controller	dimensions	(L x W x H): 111.5 x 162 x 138mm								
	features	touch keys, trigger function, synchronisation, storage of 20 configurations (for sensors with different ranges) LED indicators, DIN rail mount, digital interfaces, free analysis, configuration and acquisition software								
Electromagnetic compatibility (EMC)		EN 50081-1 and EN 61000-6-2								

FSO = Full Scale Output

All data at constant ambient temperature against optical flat at 2kHz, specifications can change when measuring different materials.

Accessories: mounting adapter

MA2400 for sensors 2400/2401 (consisting of a mounting block and a mounting ring)

mounting block

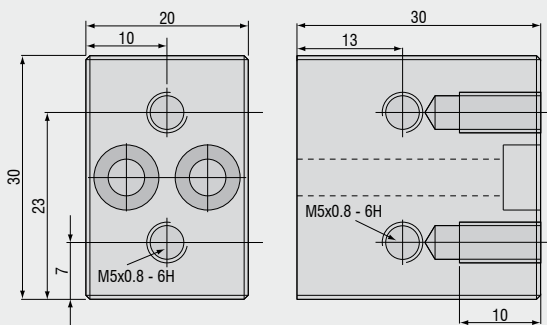

mounting ring

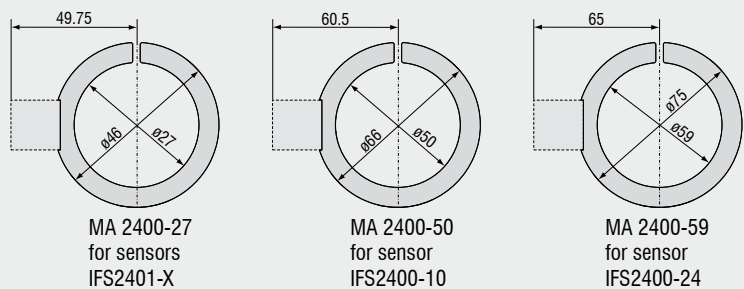

optoNCDT 2402 Confocal miniature sensors



- Miniature sensors \varnothing 4mm
- One-sided thickness measurement of transparent materials and multi-layers
- Measure inside bores and cavities from \varnothing 4.5mm
- Robust housing (steel)
- Axial or radial (90°) measuring direction
- ATEX / EX approved for hazardous areas

The miniaturised series optoNCDT 2402 offers all advantages of the confocal measurement principle, with only 4mm outer diameter. Due to a unique and patented lens design, this compact sensor allows measuring in narrow cavities and bores. Sensors with axial measuring direction and sensors with 90° beam exit are available, which can measure radially in small cavities and bores. For mounting in magnetic environments sensors with titanium housing are available.

IFS 2402-0.4/1.5/4/10

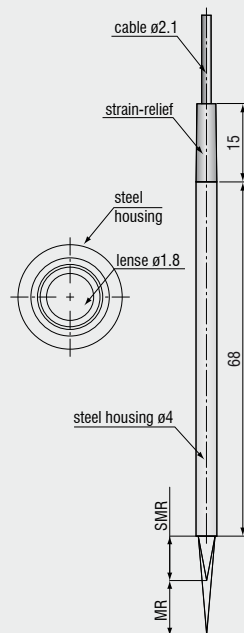

Tolerance ± 0.1 mm

MR = Measuring Range SMR = Start of Measuring Range Dimensions in mm.

IFS 2402/90-1.5/4/10

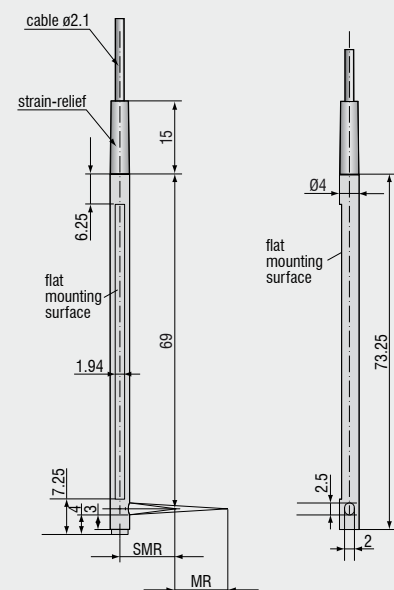

Tolerance ± 0.1 mm

MR = Measuring Range SMR = Start of Measuring Range Dimensions in mm.

Controller		IFC2401						
		IFS 2402-0.4	IFS 2402-1.5	IFS 2402/90-1.5	IFS 2402-4	IFS 2402/90-4	IFS 2402-10	IFS 2402/90-10
Sensor model (miniature version)		IFS 2402-0.4	IFS 2402-1.5	IFS 2402/90-1.5	IFS 2402-4	IFS 2402/90-4	IFS 2402-10	IFS 2402/90-10
Measuring range		400µm	1.5mm	1.5mm	3.5mm	2.5mm	6.5mm	6.5mm
Start of measuring range approx.		1.5mm	0.9mm	2.5mm ¹⁾	1.9mm	2.5mm ¹⁾	2.5mm	3.5mm ¹⁾
Spot diameter		10µm	20µm	20µm	20µm	20µm	100µm	100µm
Linearity		~0.3µm	1.2µm	1.2µm	~3µm	2µm	13µm	13µm
Resolution		0.016µm	0.06µm	0.06µm 0.004% FSO	0.14µm	0.1µm	~0.7µm 0.01% FSO	~0.7µm
Weight		15g						
Max. tilt (direct reflexion)		±8°	±5°	±5°	±3°	±3°	±1.5°	±1.5°
Measuring rate		adjustable 100Hz ... 2000Hz (optional 30kHz: series 2431 with external light source)						
Ambient light		30.000 lx						
Light source		LED						
Protection class (sensor/controller)		IP 40						
Operation temperature		+10°C ... +50°C						
Storage temperature		-30°C ... +70°C						
Output		2x 0 - 10V (15 Bit) / RS 232 / RS 422 / USB 2.0						
Supply		24VDC						
Sensor cable (fiber optic cable)		length: integral cable 2m; option up to 50m bending radius: static 30mm; dynamic 40mm						
Controller dimensions		(L x W x H): 111.5 x 162 x 138mm						
Controller features		touch keys, trigger function, synchronisation, storage of 20 configurations (for sensors with different ranges) LED indicators, DIN rail mount, digital interfaces, free analysis, configuration and acquisition software						
Electromagnetic compatibility (EMC)		EN 50081-1 and EN 61000-6-2						

FSO = Full Scale Output

¹⁾ Start of measuring range measured from sensor axis

All data at constant ambient temperature against optical flat at 2kHz, specifications can change when measuring different materials.

Accessories: mounting adapter

MA2402 for sensors 2402

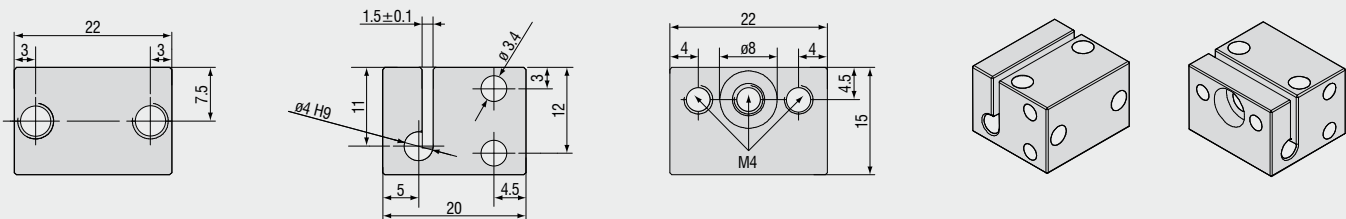

optoNCDT 2403 Confocal hybrid sensors

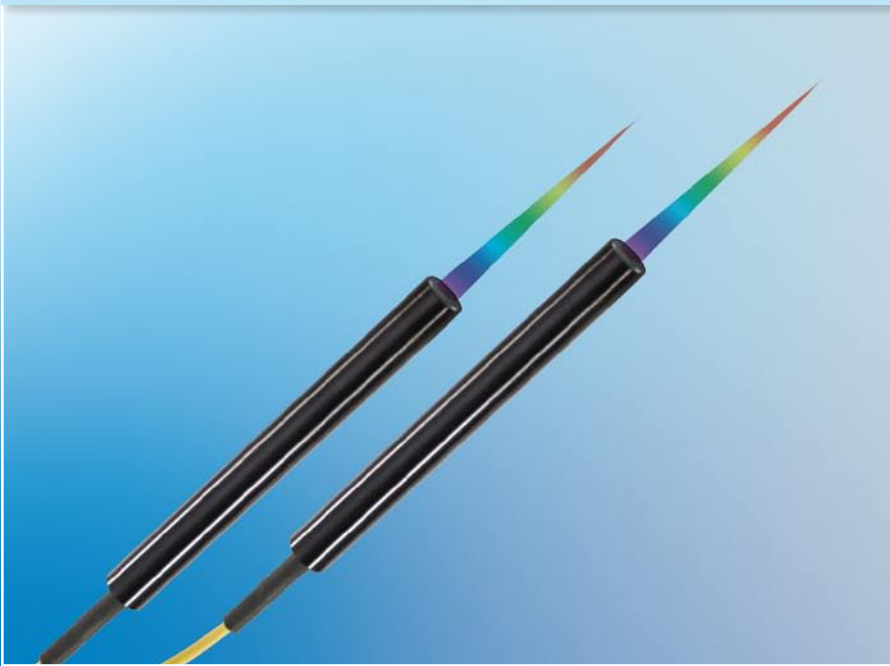

- Hybrid sensors \varnothing 8mm
- One-sided thickness measurement of transparent materials and multi-layers
- Gradient index lens with relay optics
- Increased stand off
- Robust steel case
- ATEX / EX approved for hazardous areas

The combination of a gradient index lens (GRIN lens) with a relay lens represents a favourable compromise between the IFS2401 standard sensors and the IFS2402 miniature sensors. The sensors of the IFS2403 series with an external diameter of 8mm can still be used for precise measurement in relatively tight installation situations. Due to the larger numerical aperture in comparison with the IFS2402, significantly larger stand off distances and steeper tilt angles can be realised than for the miniature sensors.

IFS 2403-0.4/1.5/4/10

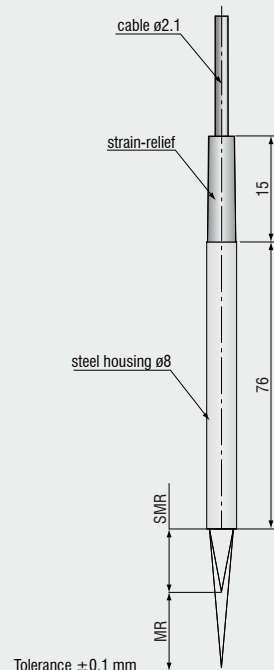

MR= Measuring Range SMR = Start of Measuring Range
Dimensions in mm.

Controller	IFC2401			
	Sensor model (GRIN lens with relay optics)	IFS 2403-0.4	IFS 2403-1.5	IFS 2403-4
Measuring range	400 μ m	1.5mm	4mm	10mm
Start of measuring range approx.	2.8mm	8.1mm	14.7mm	11mm
Spot diameter	9 μ m	15 μ m	28 μ m	56 μ m
Linearity	\sim 0.3 μ m	1.2 μ m $\leq \pm 0.08\%$ FSO	\sim 3 μ m	20 μ m $\leq \pm 0.2\%$ FSO
Resolution	0.016 μ m	0.06 μ m 0.004% FSO	0.16 μ m	1 μ m 0.01% FSO
Weight	25g			
Max. tilt (direct reflexion)	$\pm 13^\circ$	$\pm 16^\circ$	$\pm 6^\circ$	$\pm 6^\circ$
Measuring rate	adjustable 100Hz ... 2000Hz (optional 30kHz: series 2431 with external light source)			
Ambient light	30.000lx			
Light source	LED			
Protection class (sensor/controller)	IP40			
Operation temperature	+10 ... +50°C			
Storage temperature	-30 ... +70°C			
Output	2x 0 - 10V (15 Bit) / RS 232 / RS 422 / USB 2.0			
Supply	24VDC			
Sensor cable (fiber optic cable)	length: integral cable 2m; option up to 50m bending radius: static 30mm; dynamic 40mm			
Controller	dimensions	(L x W x H): 111.5 x 162 x 138mm		
	features	touch keys, trigger function, synchronisation, storage of 20 configurations (for sensors with different ranges), LED indicators, DIN rail mount, digital interfaces, free analysis, configuration and acquisition software		
Electromagnetic compatibility (EMC)	EN 50081-1 and EN 61000-6-2			

FSO = Full Scale Output

All data at constant ambient temperature against optical flat at 2kHz, specifications can change when measuring different materials.

Confocal chromatic displacement sensors

System structure

A measurement system IFD2401 consists of the IFS240x sensor, a C2401-x optical cable and the IFC24x1 controller. The sensor is calibrated to the corresponding controller. Up to 20 different sensor characteristics can be stored in one controller.



Fibre cable info

Temperature range: -50°C to 90°C

Cut: APC-Cut

Bending Radius: 30/40mm

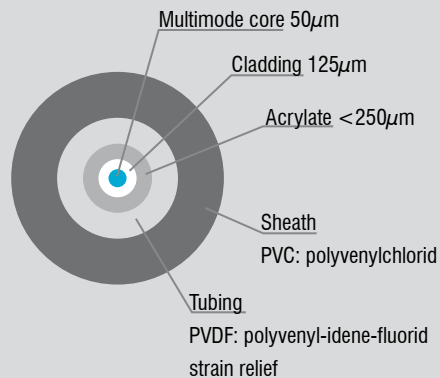

Software 2400/2401/2402/2403:

Demo software Free demo software tool included in delivery

Multipeak Software Multiple layer thickness measurement of up to 5 layers with different data interfaces

Accessories 2400/2401/2402/2403:

IFL2431/Xe/300 Xenon light source for confocal controller IFC2431 (30kHz)

PS2010 Power supply 24V / 2.5A

Accessories 2400/2401:

C2401/vac Vacuum feedthrough for optical fibre cables

C2401-X Fiber optic cable (3m, 10m, custom length up to 50m)

C2401/PT-X Armored cable (3m, 10m, custom length up to 50m)

Accessories 2402/2403:

C2402/vac Vacuum feedthrough with optical fibre cable

CE2402-x Sensor cable extension (3m, 10m, 13m, 30m, 50m)

Option PT Sensor with armored cable (3m, 10m, custom length up to 50m)

Controller IFC2401

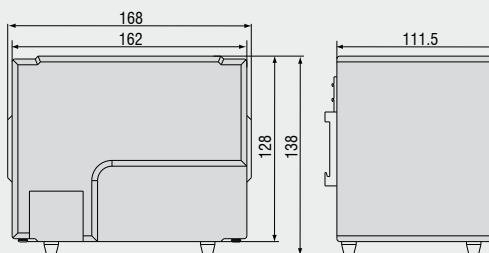

(Dimensions in mm, not to scale)

Easy to plug: E2000 standard connector

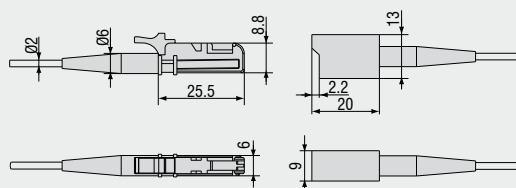

Svensk generalagent och distributör:
Sensotest AB
Girovägen 13 - 17562 Järfälla
Tel: 08-564 733 80 - Fax: 08-564 733 89
www.sensotest.se - info@sensotest.se